

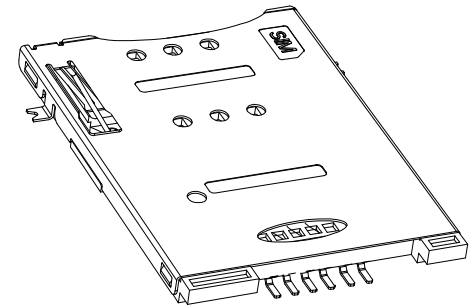

REV.	ECN NO OR DESCRIPTION	REVISED	DATE

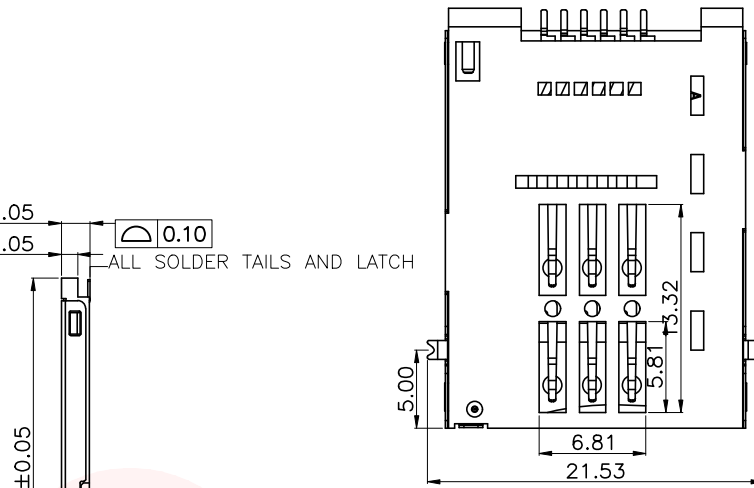
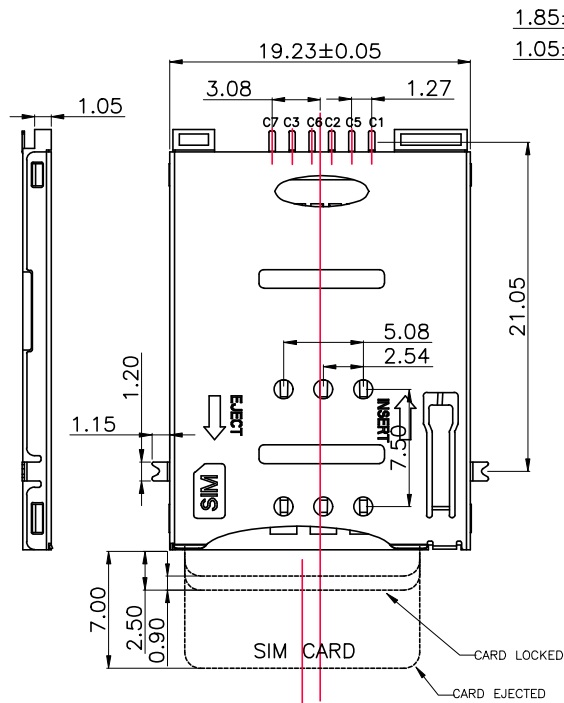
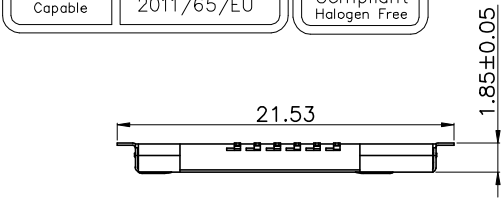

1.SPECIFICATIONS
 INSULATION RESISTANCE: 500M min.AT DC 500V DC
 WITHSTANDING VOLTAGE: 250V ACrms FOR 1 MINUTE
 CONTACT RESISTANCE: 100M max. AT 10MA/20mV max
 CURRENT RATING: 0.5A
 VOLTAGE RATING: 5.0 vrms
 OPERATING TEMP.RANGE:-55 C+85 C
 MATING CYCLES: 5000 INSERTIONS

2.MATERIAL:
 INSULATOR: H-TEMPERATURE PLASTIC,UL 94V-0,
 COLOR"BLACK
 TERMINAL: COPPER ALLOY,T=0.15mm
 SHELL: STAINLESS STELL,T=0.15mm

3.FINISH:
 TERMINAL:50u" min NICKEL UNDERPLATED ON ALLOVER,GOLD PLATING
 ON CONTACT ARER, 80u"min TIN ON SOLDER TAIL.
 SHELL:50u" NICKEL UNDERPLATED ON ALLOVER, GOLD FLASH ON SOLDER LATCH

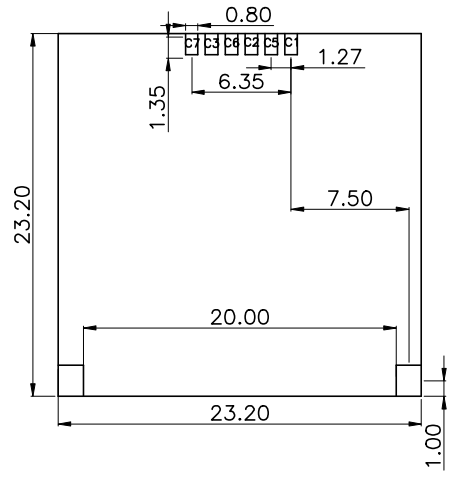
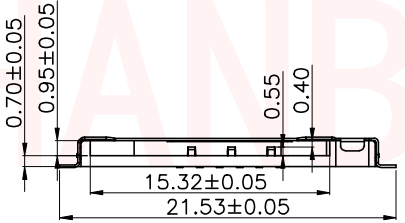

RECOMMENDED PCB LAYOUT
 GENERAL TOLERANCE ±0.05

pin no.	name
C1	vcc of sim
C2	rst of sim
C3	clk of sim
C5	gnd of sim
C6	vpp of sim
C7	I/O of sim
C4/C8	n/a

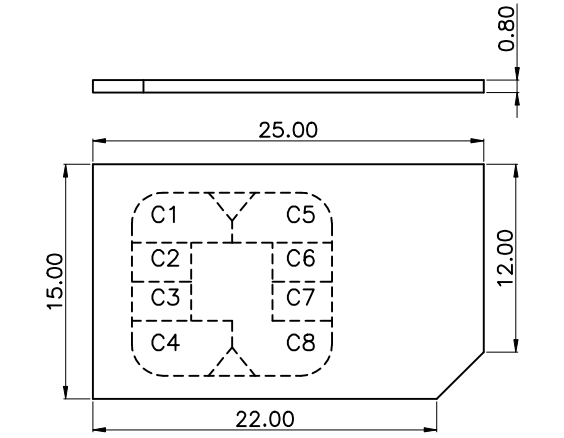

UNLESS OTHERWISE SPECIFIED TOLERANCES

DECIMALS: X :±0.5 X.X :±0.20 X.XX :±0.10

ANGLES: X :±2° X.X :±1°

东 莞 市 汉 博 电 子 科 技 有 限 公 司
 DONGGUAN HANBO TECHNOLOGY CO., LTD

TITLE Mini Sim Card Push Push 6P Smt 插 桩

DWN xiong SIM-207

CHKD lee SCALE:1:1 UNIT: mm

APVD wang SIZE: A4 SHEET:10F 1 REV: A4

CUSTOMER COPY