



产品名称 Product name

- ▶ 1.27PH H1.0 2*nPIN 90
- ▶ 度 W3.4 PC3.4 PA4.0
- ▶ PB3.8 L10.5/13.0 弯平面

产品应用场景 Product application scenario

- ▶ 电子通讯/数码产品/家用电器
- ▶ 外围设备/汽车/医疗设备等.
- ▶ Electronic communication/digital products/household appliance peripherals/AuTomobile/medical equipment, etc

产品参数/Product parameters

额定电流 (Rated current): 1A AC/DC

盐雾实验 (Life Test): 48 hours

接触电阻 (Contact Resistance): 20mΩ

绝缘电阻 (Insulation Resistance): 1000MΩ min.

耐电压 (Withstand voltage): AC 500V

工作温度 (Operating Temperature): -40° C to 105°

防火等级 (Fire rating): Polyester (UL94V-0)

触点电镀 (Dielectric Strength): Gold Flash

耐高温范围/时长 (High temperature resistance range/duration): 260° C for 5seconds

包装方式 (Packaging method): 袋装

材质/MATERIALS:

No.	名称/NAME	材料/MATERIAL	表面处理/颜色 Surfacetreatment/color
①	端子/Terminal	Brass/C2680	镀金 gold-plating
②	塑胶/plastic cement	PBT/PA6T	黑色 Black

产品PIN位示意图/Schematic diagram of product PIN

No. of	DIM. A	DIM. B	No. of	DIM. A	DIM. B	No. of	DIM. A	DIM. B	No. of	DIM. A	DIM. B	No. of	DIM. A	DIM. B
1	—	—	2*11P	12.70	13.97	2*21P	25.40	26.67	2*31P	38.10	39.37	2*41P	50.80	52.07
2*2P	1.27	2.54	2*12P	13.97	15.24	2*22P	26.67	27.94	2*32P	39.37	40.64	2*42P	52.07	53.34
2*3P	2.54	3.81	2*13P	15.24	16.51	2*23P	27.94	29.21	2*33P	40.64	41.91	2*43P	53.34	54.61
2*4P	3.81	5.08	2*14P	16.51	17.78	2*24P	29.21	30.48	2*34P	41.91	43.18	2*44P	54.61	55.88
2*5P	5.08	6.35	2*15P	17.78	19.05	2*25P	30.48	31.75	2*35P	43.18	44.45	2*45P	55.88	57.15
2*6P	6.35	7.62	2*16P	19.05	20.32	2*26P	31.75	33.02	2*36P	44.45	45.72	2*46P	57.15	58.42
2*7P	7.62	8.89	2*17P	20.32	21.59	2*27P	33.02	34.29	2*37P	45.72	46.99	2*47P	58.42	59.69
2*8P	8.89	10.16	2*18P	21.59	22.86	2*28P	34.29	35.56	2*38P	46.99	48.26	2*48P	59.69	60.96
2*9P	10.16	11.43	2*19P	22.86	24.13	2*29P	35.56	36.83	2*39P	48.26	49.53	2*49P	60.96	62.23
2*10P	11.43	12.70	2*20P	24.13	25.40	2*30P	36.83	38.10	2*40P	49.53	50.80	2*50P	62.23	63.50

产品编号/Product No



- 1: Series No:
PH-Pin Header
- 2: 焊接板类型/Welding Board Type:
8-90度双排弯平面/ SMT Type
with Locating Peg
- 3: 产品间距/Product spacing
127-1.27mm
200-2.00mm
254-2.54mm
- 4: PIN位/PIN bit
2*2P-22P

- 5: 颜色/Color:
B-Black
- 6: 材料/Material
1-PBT 2-PA6T
- 7: 触点电镀/Contact Plating
GO-Gold Flash
- 8: 包装方式/Packgin Method
P-袋装/PE B-盒装/BOX
T-管装/Tubing W-卷带/winding
- 9: Serial Code



产品订购号示意图/Schematic diagram of product order number

Schematic diagram of product order number: HB-PH8-12722PB2G0P



产品外形尺寸图/Outline dimension drawing of product

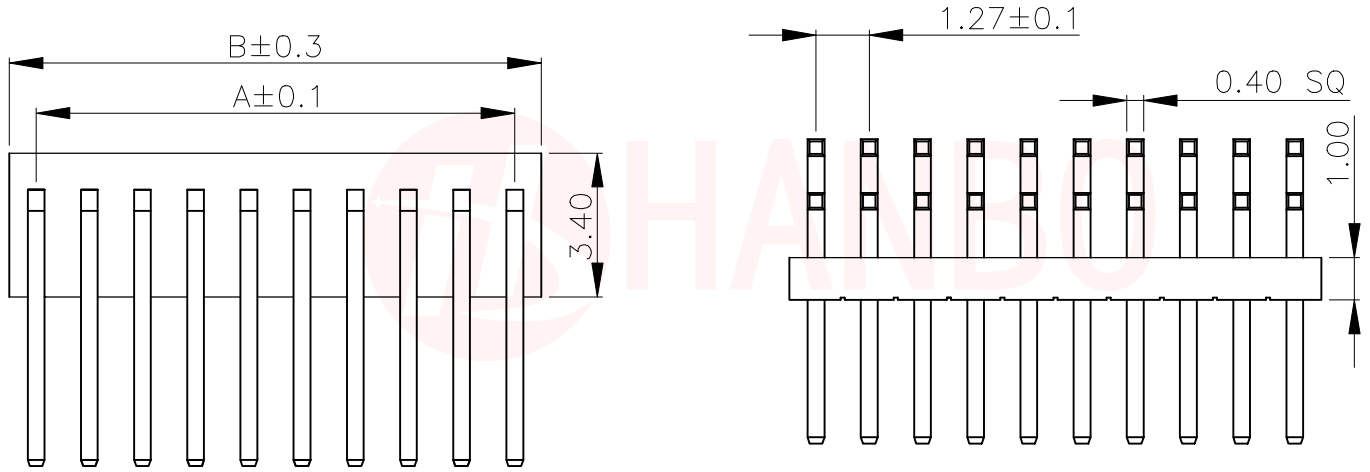

线路图/Circuit diagram

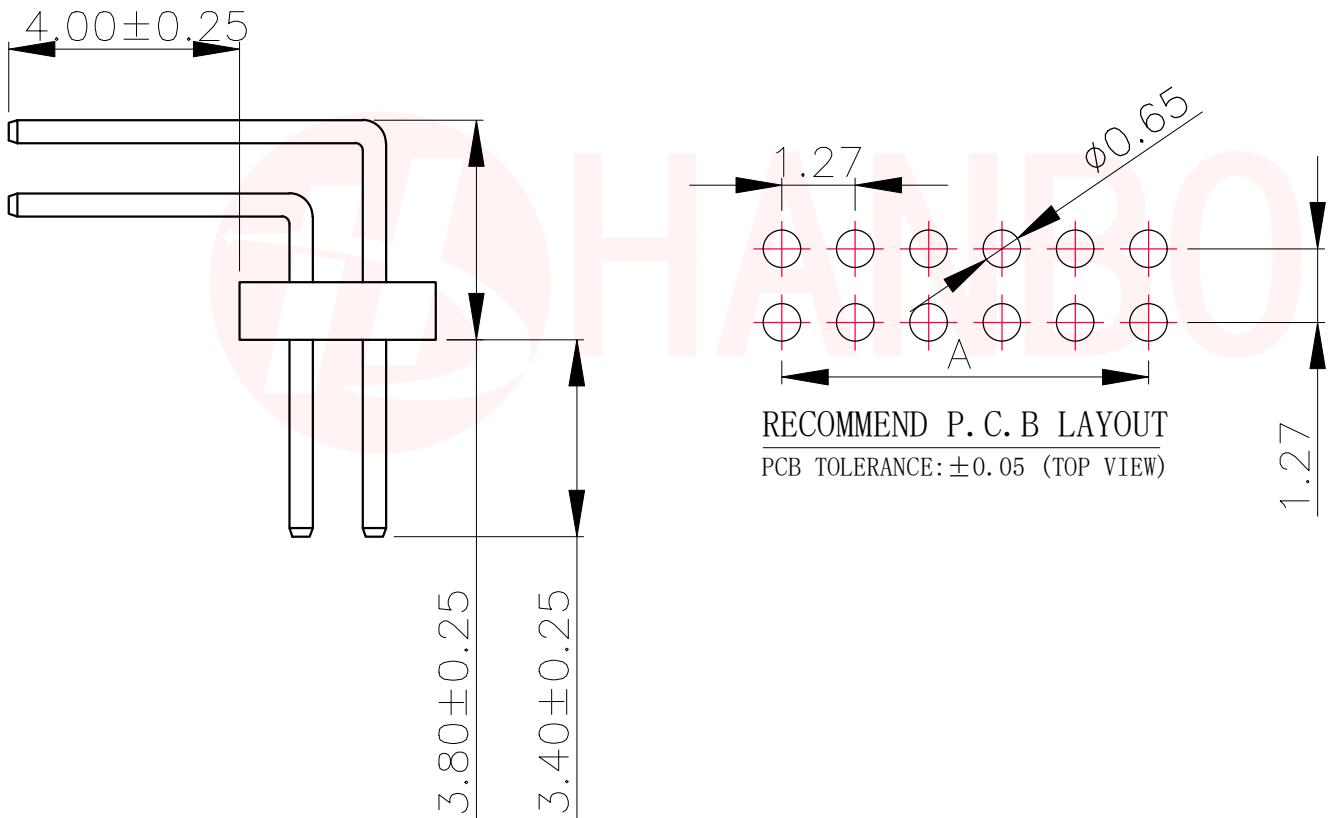

TACT Switch™

连接器领域专家
让世界连接更清晰

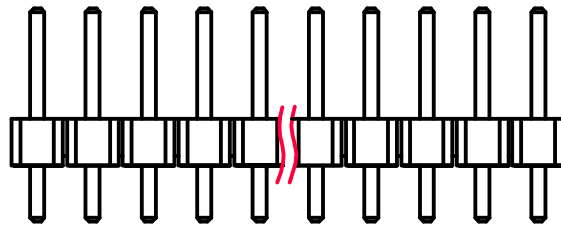

产品

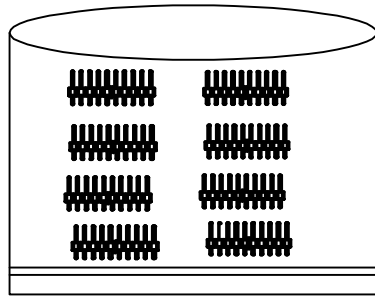
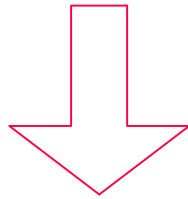

3#胶袋: 16*18cm

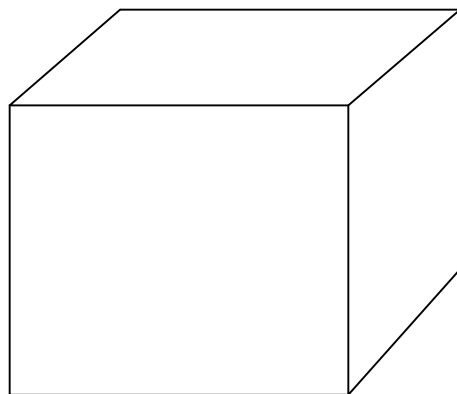
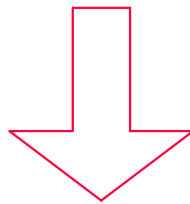

纸箱

TACT Switch™

连接器领域专家 让世界连接更清晰