

产品名称 Product name

- ▶ 1.27PH H1.0 1*pin SMT
- ▶ W2.0 PC4.3 PA4.0 PB1.5 L7.2 (左前右后)

产品应用场景 Product application scenario

- ▶ 电子通讯/数码产品/家用电器
- ▶ 外围设备/汽车/医疗设备等.
- ▶ Electronic communication/digital products/household appliance peripherals/AuTomobile/medical equipment, etc

产品参数/Product parameters

额定电流 (Rated current): 1A AC/DC

盐雾实验 (Life Test): 48 hours

接触电阻 (Contact Resistance): 20mΩ

绝缘电阻 (Insulation Resistance): 1000MΩ min.

耐电压 (Withstand voltage): AC 500V

工作温度 (Operating Temperature): -40° C to 105°

防火等级 (Fire rating): Polyester (UL94V-0)

触点电镀 (Dielectric Strength): Gold Flash

耐高温范围/时长 (High temperature resistance range/duration): 260° C for 5seconds

包装方式 (Packaging method): 袋装

材质/MATERIALS:

No.	名称/NAME	材料/MATERIAL	表面处理/颜色 Surfacetreatment/color
①	端子/Terminal	Brass/C2680	镀金 gold-plating
②	塑胶/plastic cement	PBT/PA6T	黑色 Black

产品PIN位示意图/Schematic diagram of product PIN

No. of	DIM. A	DIM. B	No. of	DIM. A	DIM. B	No. of	DIM. A	DIM. B	No. of	DIM. A	DIM. B	No. of	DIM. A	DIM. B
1	—	—	1*11P	12.70	13.97	1*21P	25.40	26.67	1*31P	38.10	39.37	1*41P	50.80	52.07
1*2P	1.27	2.54	1*12P	13.97	15.24	1*22P	26.67	27.94	1*32P	39.37	40.64	1*42P	52.07	53.34
1*3P	2.54	3.81	1*13P	15.24	16.51	1*23P	27.94	29.21	1*33P	40.64	41.91	1*43P	53.34	54.61
1*4P	3.81	5.08	1*14P	16.51	17.78	1*24P	29.21	30.48	1*34P	41.91	43.18	1*44P	54.61	55.88
1*5P	5.08	6.35	1*15P	17.78	19.05	1*25P	30.48	31.75	1*35P	43.18	44.45	1*45P	55.88	57.15
1*6P	6.35	7.62	1*16P	19.05	20.32	1*26P	31.75	33.02	1*36P	44.45	45.72	1*46P	57.15	58.42
1*7P	7.62	8.89	1*17P	20.32	21.59	1*27P	33.02	34.29	1*37P	45.72	46.99	1*47P	58.42	59.69
1*8P	8.89	10.16	1*18P	21.59	22.86	1*28P	34.29	35.56	1*38P	46.99	48.26	1*48P	59.69	60.96
1*9P	10.16	11.43	1*19P	22.86	24.13	1*29P	35.56	36.83	1*39P	48.26	49.53	1*49P	60.96	62.23
1*10P	11.43	12.70	1*20P	24.13	25.40	1*30P	36.83	38.10	1*40P	49.53	50.80	1*50P	62.23	63.50

产品编号/Product No



- 1: Series No:
PH-Pin Header
- 2: 焊接板类型/Welding Board Type:
6-左前右后贴片/SMT Type with Locating Peg
- 3: 产品间距/Product spacing
127-1.27mm
200-2.00mm
254-2.54mm
- 4: PIN位/PIN bit
1*2P-12P

- 5: 颜色/Color:
B-Black
- 6: 材料/Material
1-PBT 2-PA6T
- 7: 触点电镀/Contact Plating
GO-Gold Flash
- 8: 包装方式/Packgin Method
P-袋装/PE B-盒装/BOX
T-管装/Tubing W-卷带/winding
- 9: Serial Code

产品订购号示意图/Schematic diagram of product order number

Schematic diagram of product order number: HB-PH6-12712PB2G0P

产品外形尺寸图/Outline dimension drawing of product

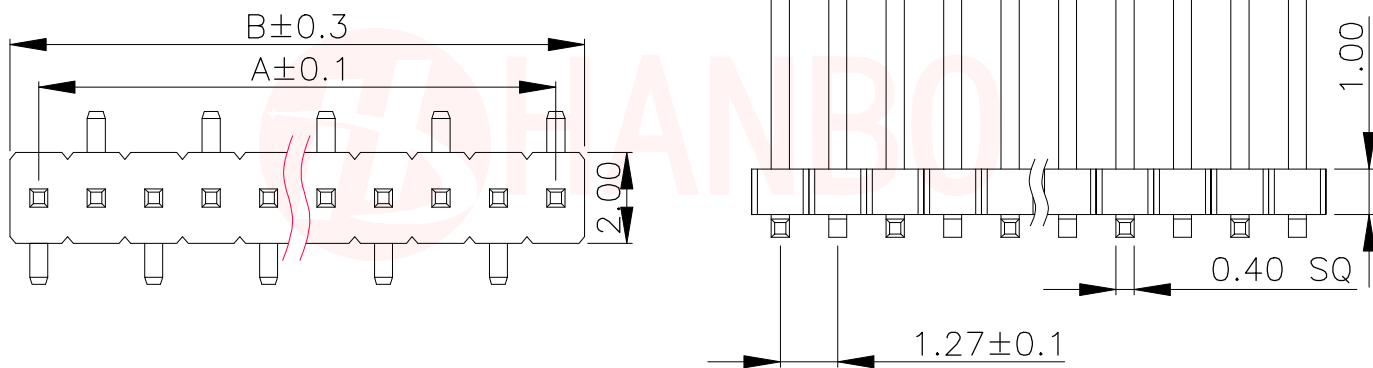

线路图/Circuit diagram

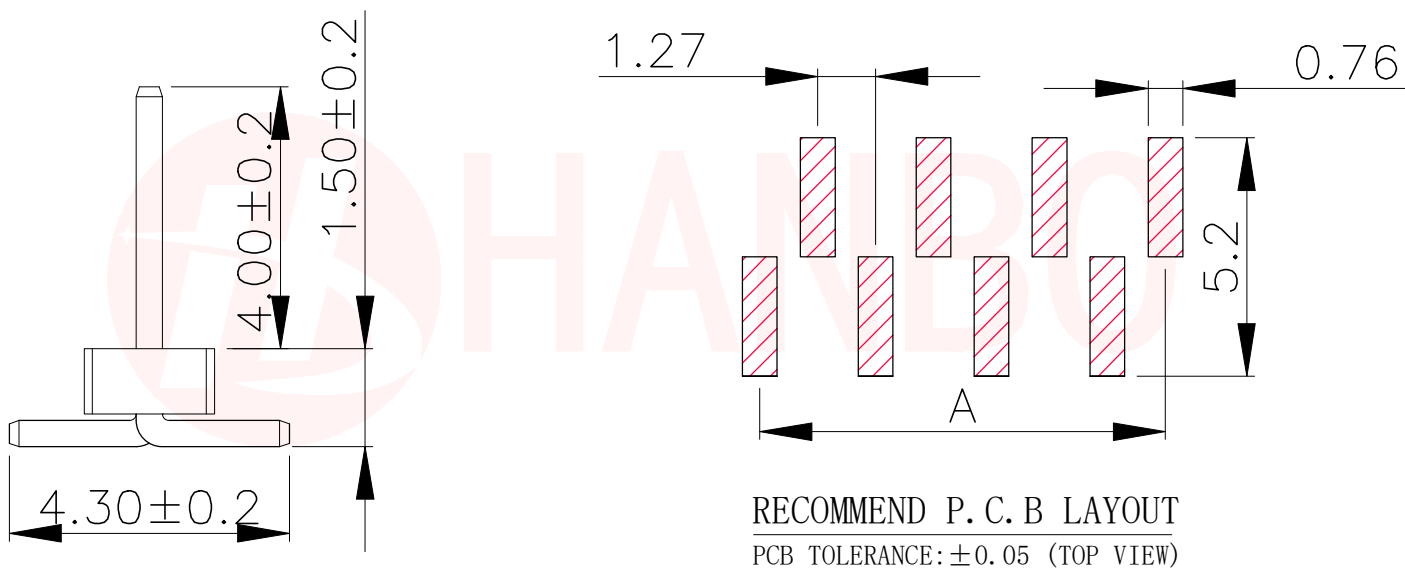

TACT Switch™

连接器领域专家
让世界连接更清晰

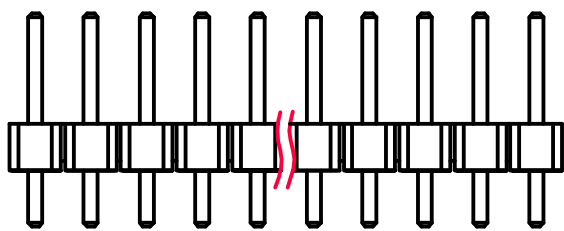

产品

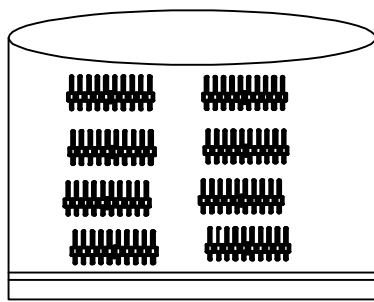
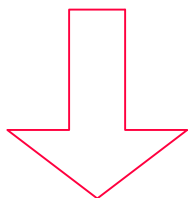

3#胶袋: 16*18cm

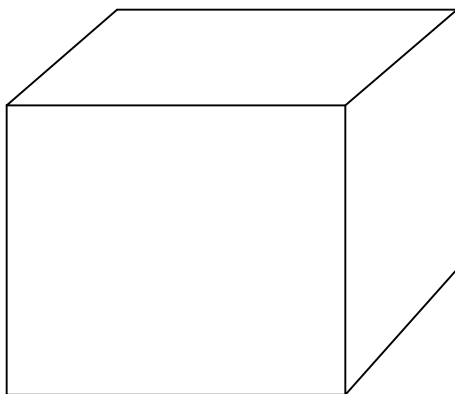
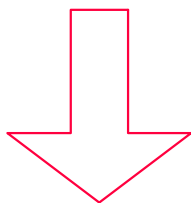

纸箱

TACT Switch™

连接器领域专家 让世界连接更清晰